

Article number: 201057281  
Description: E+G Handwheel  
GN 949-100-B12-D

## Measures

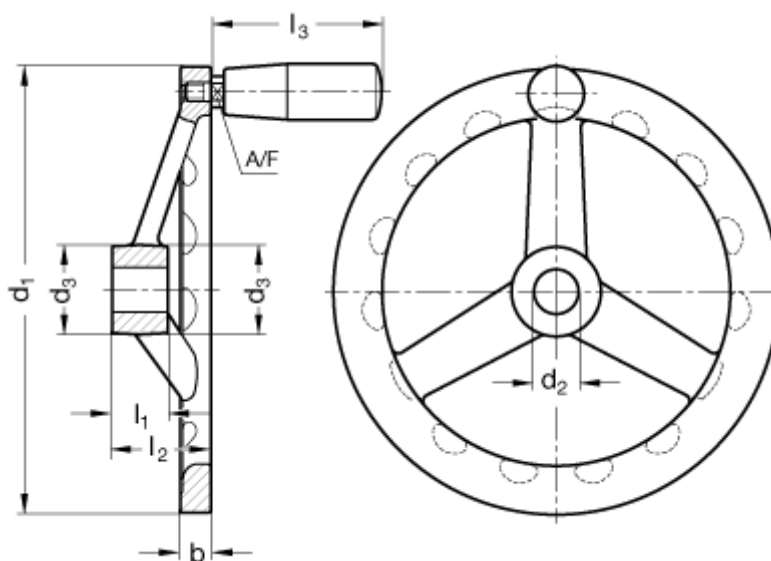

A/F	= 9	l3	= 45
b	= 7	Number of spokes	= 3
d1	= 100		
d2	= 12		
d3	= 20		
Handle diameter	= 18		
l1	= 15		
l2	= 27,5		